

# ROTARY INSTRUMENTS $\varnothing 1.0\text{mm}$

## Diamond Burs

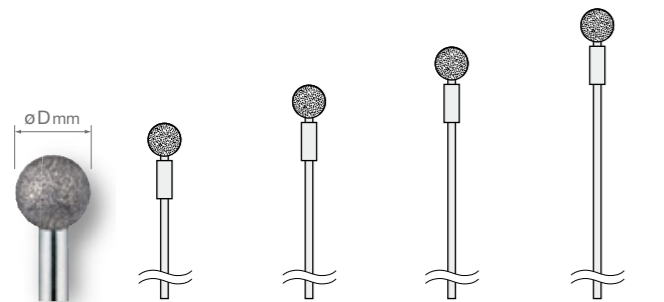

D Head Diameter	Long	Extra Long	Super Long	Special Long
	for P200-1A135 PD-1A135	for P200-1A155 P200-1A155-C PD-1A155-10	for P200-1A175 P200-1A175-C PD-1A175-10	for P200-RA330 PD-RA330
2.0	PDS-1D135-20	PDS-1D155-20	PDS-1D175-20	PDS-1D330-20
2.5	—	—	—	PDS-1D330-25
3.0	PDS-1D135-30	PDS-1D155-30	PDS-1D175-30	PDS-1D330-30
3.5	—	—	—	PDS-1D330-35
4.0	PDS-1D135-40	PDS-1D155-40	PDS-1D175-40	—

## Coarse Diamond Burs

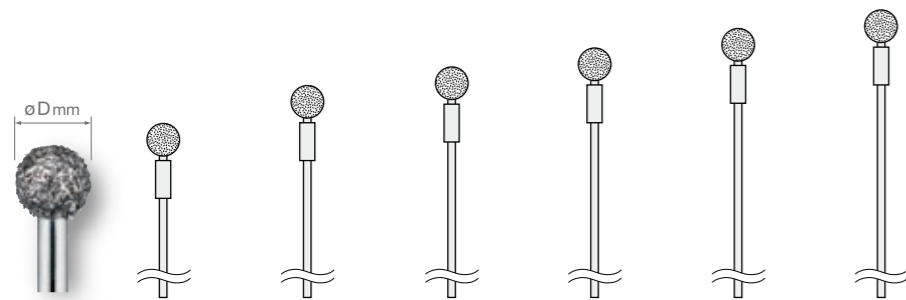

D Head Diameter	Long	Extra Long	Extra Long [Extended]	Super Long	Super Long [Extended]	Special Long
	for P200-1A135 PD-1A135	for P200-1A155 P200-1A155-C PD-1A155-10	for P200-1A155 P200-1A155-C PD-1A155-10	for P200-1A175 P200-1A175-C PD-1A175-10	for P200-1A175 P200-1A175-C PD-1A175-10	for P200-RA330 PD-RA330
2.0	PDS-1CD135-20	PDS-1CD155-20	PDS-1CD155-20E	PDS-1CD175-20	PDS-1CD175-20E	PDS-1CD330-20
2.5	—	—	—	—	—	PDS-1CD330-25
3.0	PDS-1CD135-30	PDS-1CD155-30	PDS-1CD155-30E	PDS-1CD175-30	PDS-1CD175-30E	PDS-1CD330-30
3.5	—	—	—	—	—	PDS-1CD330-35
4.0	PDS-1CD135-40	PDS-1CD155-40	—	PDS-1CD175-40	—	—

Extended bur: Burs extend 6mm beyond Long type



# ROTARY INSTRUMENTS $\varnothing 1.0\text{mm}$

## Neuro Diamond Burs

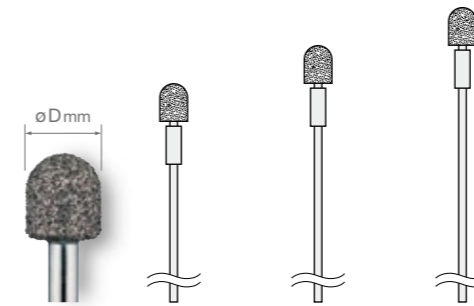

D Head Diameter	Long	Extra Long	Super Long
	for P200-1A135 PD-1A135	for P200-1A155 P200-1A155-C PD-1A155-10	for P200-1A175 P200-1A175-C PD-1A175-10
2.0	PDS-1ND135-20	PDS-1ND155-20	PDS-1ND175-20
3.0	PDS-1ND135-30	PDS-1ND155-30	PDS-1ND175-30
4.0	PDS-1ND135-40	PDS-1ND155-40	PDS-1ND175-40

## Neuro Coarse Diamond Burs

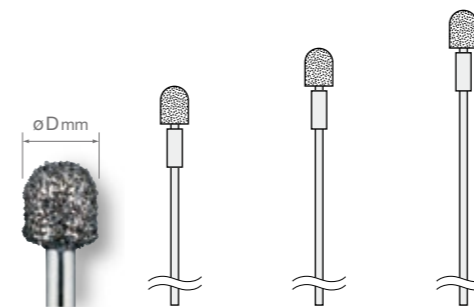

D Head Diameter	Long	Extra Long	Super Long
	for P200-1A135 PD-1A135	for P200-1A155 P200-1A155-C PD-1A155-10	for P200-1A175 P200-1A175-C PD-1A175-10
2.0	PDS-1NCD135-20	PDS-1NCD155-20	PDS-1NCD175-20
3.0	PDS-1NCD135-30	PDS-1NCD155-30	PDS-1NCD175-30
4.0	PDS-1NCD135-40	PDS-1NCD155-40	PDS-1NCD175-40



# ROTARY INSTRUMENTS $\varnothing 2.35\text{mm}$

## Round Fluted Burs

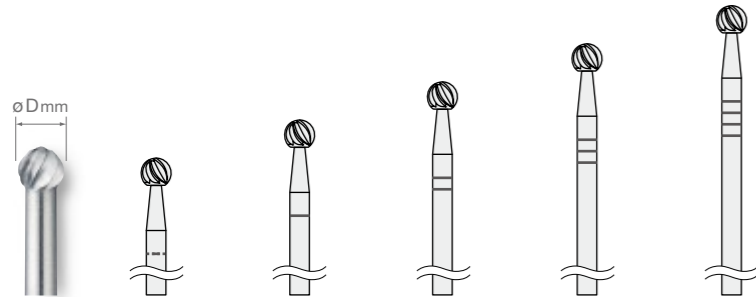

D Head Diameter	MS for P200-2AMS P200-2SMS	Extra Short for P200-2AES P200-2SES PD-2AES PD-2SES	Short for P200-2AS P200-2SS PD-2AS PD-2SS	Medium for P200-2AM P200-2SM PD-2AM PD-2SM	Long for P200-2AL P200-2SL PD-2AL
1.0	PDS-2CMS-10	PDS-2CES-10	PDS-2CS-10	PDS-2CM-10	—
2.0	PDS-2CMS-20	PDS-2CES-20	PDS-2CS-20	PDS-2CM-20	PDS-2CL-20
3.0	PDS-2CMS-30	PDS-2CES-30	PDS-2CS-30	PDS-2CM-30	PDS-2CL-30
4.0	PDS-2CMS-40	PDS-2CES-40	PDS-2CS-40	PDS-2CM-40	PDS-2CL-40
5.0	PDS-2CMS-50	PDS-2CES-50	PDS-2CS-50	PDS-2CM-50	PDS-2CL-50
6.0	PDS-2CMS-60	PDS-2CES-60	PDS-2CS-60	PDS-2CM-60	PDS-2CL-60
7.0	PDS-2CMS-70	PDS-2CES-70	PDS-2CS-70	PDS-2CM-70	PDS-2CL-70

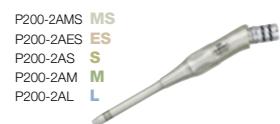

# ROTARY INSTRUMENTS $\varnothing 2.35\text{mm}$

## Diamond Burs

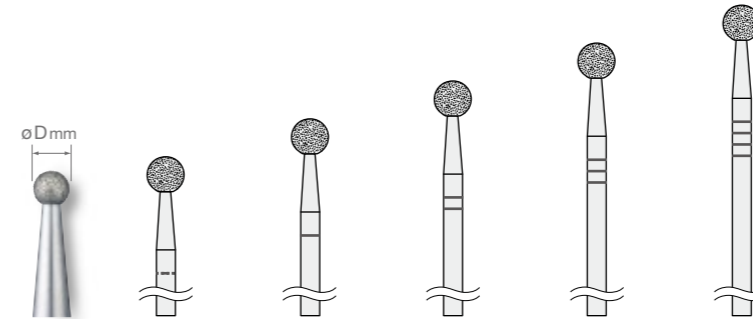

D Head Diameter	MS for P200-2AMS P200-2SMS	Extra Short for P200-2AES P200-2SES PD-2AES PD-2SES	Short for P200-2AS P200-2SS PD-2AS PD-2SS	Medium for P200-2AM P200-2SM PD-2AM PD-2SM	Long for P200-2AL P200-2SL PD-2AL
0.6	PDS-2DMS-06	PDS-2DES-06	PDS-2DS-06	—	—
1.0	PDS-2DMS-10	PDS-2DES-10	PDS-2DS-10	PDS-2DM-10	—
1.5	PDS-2DMS-15	PDS-2DES-15	PDS-2DS-15	—	—
2.0	PDS-2DMS-20	PDS-2DES-20	PDS-2DS-20	PDS-2DM-20	PDS-2DL-20
3.0	PDS-2DMS-30	PDS-2DES-30	PDS-2DS-30	PDS-2DM-30	PDS-2DL-30
4.0	PDS-2DMS-40	PDS-2DES-40	PDS-2DS-40	PDS-2DM-40	PDS-2DL-40
5.0	PDS-2DMS-50	PDS-2DES-50	PDS-2DS-50	PDS-2DM-50	PDS-2DL-50
6.0	PDS-2DMS-60	PDS-2DES-60	PDS-2DS-60	PDS-2DM-60	PDS-2DL-60
7.0	PDS-2DMS-70	PDS-2DES-70	PDS-2DS-70	PDS-2DM-70	PDS-2DL-70



# ROTARY INSTRUMENTS $\varnothing 2.35\text{mm}$

## Coarse Diamond Burs

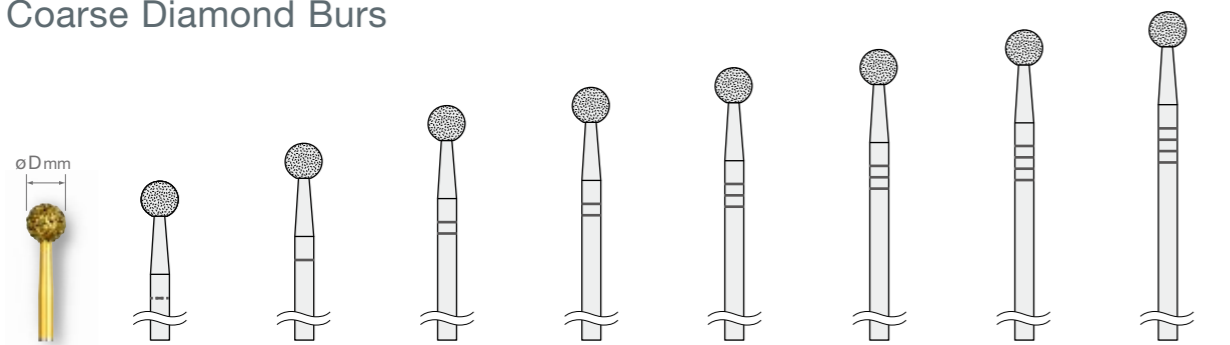

D Head Diameter	MS for P200-2AMS P200-2SMS	Extra Short for P200-2AES P200-2SES PD-2AES PD-2SES	Short for P200-2AS P200-2SS PD-2AS PD-2SS	Short [Extended] for P200-2AS P200-2SS PD-2AS PD-2SS	Medium for P200-2AM P200-2SM PD-2AM PD-2SM	Medium [Extended] for P200-2AM P200-2SM PD-2AM PD-2SM	Long for P200-2AL P200-2SL PD-2AL	Long [Extended] for P200-2AL P200-2SL PD-2AL
1.0	PDS-2CDMS-10	PDS-2CDES-10	PDS-2CDS-10	—	—	—	—	—
1.5	PDS-2CDMS-15	PDS-2CDES-15	PDS-2CDS-15	—	—	—	—	—
2.0	PDS-2CDMS-20	PDS-2CDES-20	PDS-2CDS-20	PDS-2CDS-20E	PDS-2CDM-20	PDS-2CDM-20E	PDS-2CDL-20	PDS-2CDL-20E
3.0	PDS-2CDMS-30	PDS-2CDES-30	PDS-2CDS-30	PDS-2CDS-30E	PDS-2CDM-30	PDS-2CDM-30E	PDS-2CDL-30	PDS-2CDL-30E
4.0	PDS-2CDMS-40	PDS-2CDES-40	PDS-2CDS-40	PDS-2CDS-40E	PDS-2CDM-40	PDS-2CDM-40E	PDS-2CDL-40	PDS-2CDL-40E
5.0	PDS-2CDMS-50	PDS-2CDES-50	PDS-2CDS-50	PDS-2CDS-50E	PDS-2CDM-50	PDS-2CDM-50E	PDS-2CDL-50	PDS-2CDL-50E
6.0	PDS-2CDMS-60	PDS-2CDES-60	PDS-2CDS-60	—	PDS-2CDM-60	—	PDS-2CDL-60	—
7.0	PDS-2CDMS-70	PDS-2CDES-70	PDS-2CDS-70	—	PDS-2CDM-70	—	PDS-2CDL-70	—

Extended bur: Burs extend 10mm beyond Long type

## Extra Coarse Diamond Burs

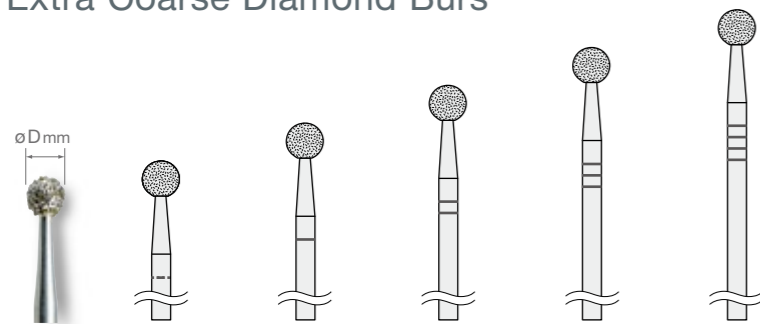

D Head Diameter	MS for P200-2AMS P200-2SMS	Extra Short for P200-2AES P200-2SES PD-2AES PD-2SES	Short for P200-2AS P200-2SS PD-2AS PD-2SS	Medium for P200-2AM P200-2SM PD-2AM PD-2SM	Long for P200-2AL P200-2SL PD-2AL
3.0	PDS-2ECDMS-30	PDS-2ECDES-30	PDS-2ECDS-30	PDS-2ECDM-30	PDS-2ECDL-30
4.0	PDS-2ECDMS-40	PDS-2ECDES-40	PDS-2ECDS-40	PDS-2ECDM-40	PDS-2ECDL-40
5.0	PDS-2ECDMS-50	PDS-2ECDES-50	PDS-2ECDS-50	PDS-2ECDM-50	PDS-2ECDL-50
6.0	PDS-2ECDMS-60	PDS-2ECDES-60	PDS-2ECDS-60	PDS-2ECDM-60	PDS-2ECDL-60
7.0	PDS-2ECDMS-70	—	—	—	—

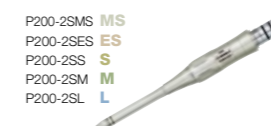
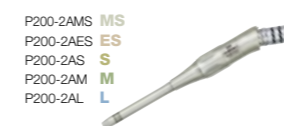
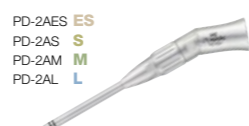
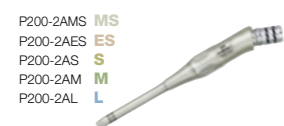

# ROTARY INSTRUMENTS $\varnothing 2.35\text{mm}$

## Super Coarse Diamond Burs

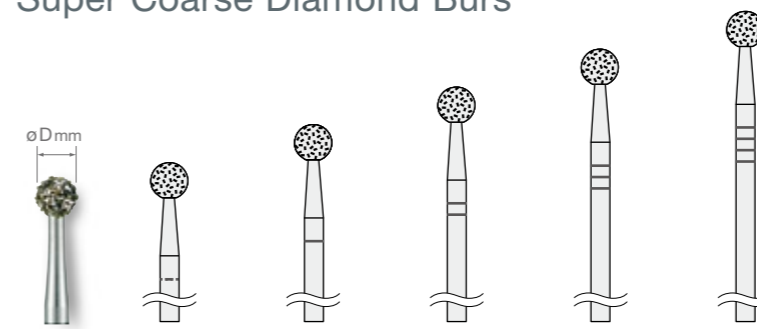

D Head Diameter	MS for P200-2AMS P200-2SMS	Extra Short for P200-2AES P200-2SES PD-2AES PD-2SES	Short for P200-2AS P200-2SS PD-2AS PD-2SS	Medium for P200-2AM P200-2SM PD-2AM PD-2SM	Long for P200-2AL P200-2SL PD-2AL
3.0	PDS-2SCDMS-30	PDS-2SCDES-30	PDS-2SCDS-30	PDS-2SCDM-30	PDS-2SCDL-30
4.0	PDS-2SCDMS-40	PDS-2SCDES-40	PDS-2SCDS-40	PDS-2SCDM-40	PDS-2SCDL-40
5.0	PDS-2SCDMS-50	PDS-2SCDES-50	PDS-2SCDS-50	PDS-2SCDM-50	PDS-2SCDL-50
6.0	PDS-2SCDMS-60	PDS-2SCDES-60	PDS-2SCDS-60	PDS-2SCDM-60	PDS-2SCDL-60

## Neuro Burs

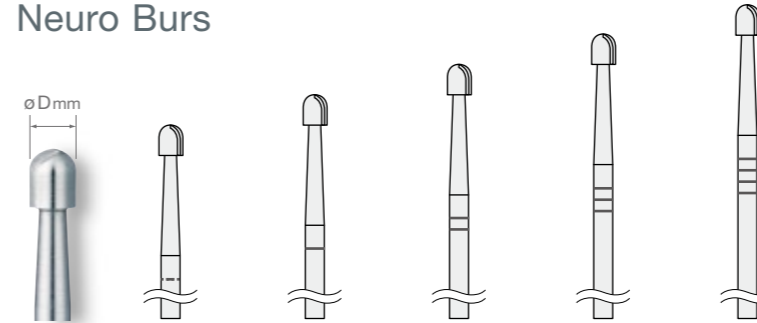

D Head Diameter	MS for P200-2AMS P200-2SMS	Extra Short for P200-2AES P200-2SES PD-2AES PD-2SES	Short for P200-2AS P200-2SS PD-2AS PD-2SS	Medium for P200-2AM P200-2SM PD-2AM PD-2SM	Long for P200-2AL P200-2SL PD-2AL
1.8	PDS-2NMS-18	PDS-2NES-18	PDS-2NS-18	PDS-2NM-18	PDS-2NL-18
3.0	PDS-2NMS-30	PDS-2NES-30	PDS-2NS-30	PDS-2NM-30	PDS-2NL-30

# ROTARY INSTRUMENTS $\varnothing 2.35\text{mm}$

## Acorn Burs

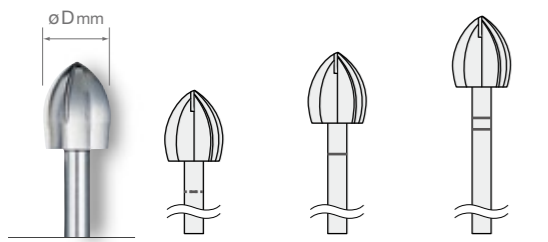

D Head Diameter	MS for P200-2AMS P200-2SMS	Extra Short for P200-2AES P200-2SES PD-2AES PD-2SES	Short for P200-2AS P200-2SS PD-2AS PD-2SS
7.5	PDS-2AMS-75	PDS-2AES-75	PDS-2AS-75

## Pear Burs

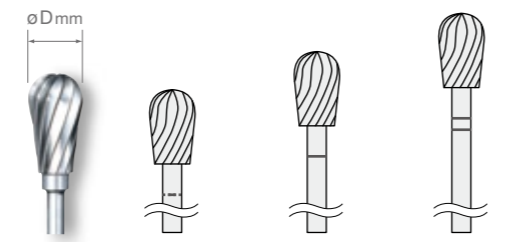

D Head Diameter	MS for P200-2AMS P200-2SMS	Extra Short for P200-2AES P200-2SES PD-2AES PD-2SES	Short for P200-2AS P200-2SS PD-2AS PD-2SS
6.0	PDS-2PMS-60	PDS-2PES-60	PDS-2PS-60

## Egg Burs

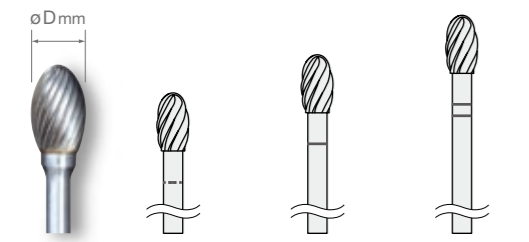

D Head Diameter	MS for P200-2AMS P200-2SMS	Extra Short for P200-2AES P200-2SES PD-2AES PD-2SES	Short for P200-2AS P200-2SS PD-2AS PD-2SS
4.0	PDS-2EMS-40	PDS-2EES-40	PDS-2ES-40
6.0	PDS-2EMS-60	PDS-2EES-60	PDS-2ES-60

## Barrel Burs



D Head Diameter	MS for P200-2AMS P200-2SMS	Extra Short for P200-2AES P200-2SES PD-2AES PD-2SES	Short for P200-2AS P200-2SS PD-2AS PD-2SS
4.0	PDS-2BMS-40	PDS-2BES-40	PDS-2BS-40
6.0	PDS-2BMS-60	PDS-2BES-60	PDS-2BS-60



# ROTARY INSTRUMENTS $\varnothing 2.35\text{mm}$

## Lindemann Burs

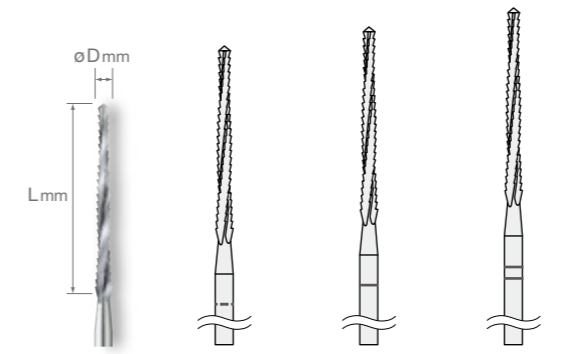

L x D Length, Head Diameter	MS for P200-2AMS P200-2SMS	Extra Short for P200-2AES P200-2SES PD-2AES PD-2SES	Short for P200-2AS P200-2SS PD-2AS PD-2SS
11 x 2.1	PDS-2LMS-11	PDS-2LES-11	PDS-2LS-11
26 x 2.3	PDS-2LMS-26	PDS-2LES-26	PDS-2LS-26

## Wirepass Drills

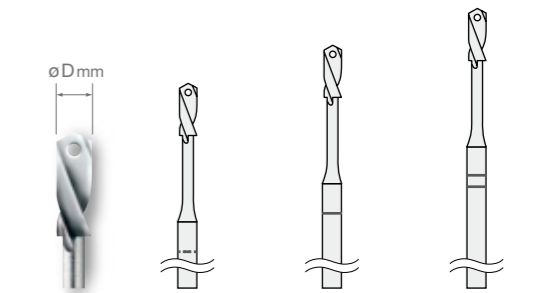

D Head Diameter	MS for P200-2AMS P200-2SMS	Extra Short for P200-2AES P200-2SES PD-2AES PD-2SES	Short for P200-2AS P200-2SS PD-2AS PD-2SS
1.0	PDS-2WMS-10	PDS-2WES-10	PDS-2WS-10
1.2	PDS-2WMS-12	PDS-2WES-12	PDS-2WS-12
1.5	PDS-2WMS-15	PDS-2WES-15	PDS-2WS-15

## Fissure Burs

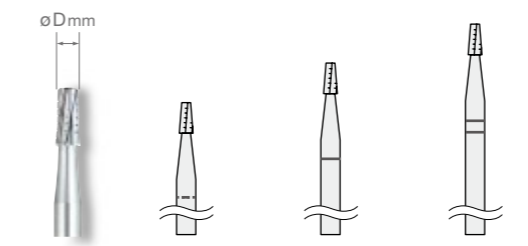

D Head Diameter	MS for P200-2AMS P200-2SMS	Extra Short for P200-2AES P200-2SES PD-2AES PD-2SES	Short for P200-2AS P200-2SS PD-2AS PD-2SS
1.2	PDS-2FMS-12	PDS-2FES-12	PDS-2FS-12
1.6	PDS-2FMS-16	PDS-2FES-16	PDS-2FS-16
2.1	PDS-2FMS-21	PDS-2FES-21	PDS-2FS-21



# ROTARY INSTRUMENTS $\varnothing 2.35\text{mm}$

## Twist Drill Flat Tail

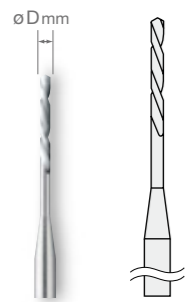

D Head Diameter	for P200-2SD PD-2SD PD-2AD
1.5	PDS-2TD-15
2.0	PDS-2TD-20

P200-2SD

PD-2SD

PD-2AD



# ROTARY INSTRUMENTS $\varnothing 3.17\text{mm}$

## Round Fluted Burs

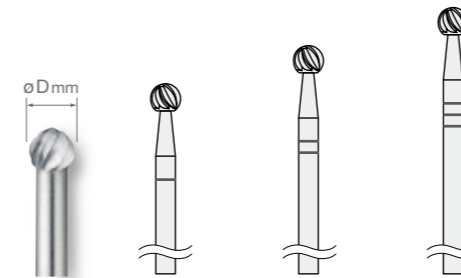

D Head Diameter	Short	Medium	Long
	for P200-3GAS	for P200-3GAM	for P200-3GAL
1.0	PDS-3CS-10	PDS-3CM-10	—
2.0	PDS-3CS-20	PDS-3CM-20	PDS-3CL-20
3.0	PDS-3CS-30	PDS-3CM-30	PDS-3CL-30
4.0	PDS-3CS-40	PDS-3CM-40	PDS-3CL-40
5.0	PDS-3CS-50	PDS-3CM-50	PDS-3CL-50
6.0	PDS-3CS-60	PDS-3CM-60	PDS-3CL-60
7.0	PDS-3CS-70	PDS-3CM-70	PDS-3CL-70

# ROTARY INSTRUMENTS $\varnothing 3.17\text{mm}$

## Craniotome Handpiece Burs

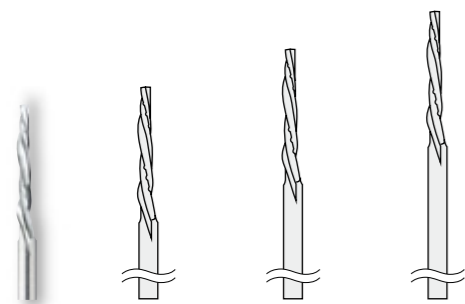

Pediatric	Medium	Long
for P200-CRD-P PD-CRD-P	for P200-CRD-M PD-CRD-M	for P200-CRD-L PD-CRD-L
PDS-CRA-P	PDS-CRA-M	PDS-CRA-L

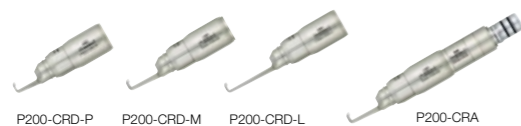

## Router Burs

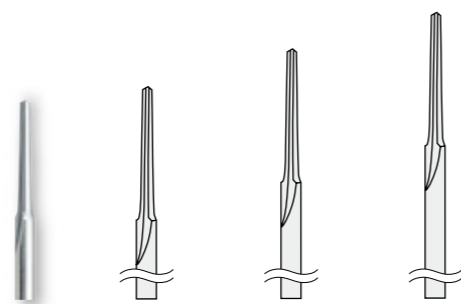

Pediatric	Medium	Long
for P200-CRD-P PD-CRD-P	for P200-CRD-M PD-CRD-M	for P200-CRD-L PD-CRD-L
PDS-ROU-P	PDS-ROU-M	PDS-ROU-L



## Diamond Burs

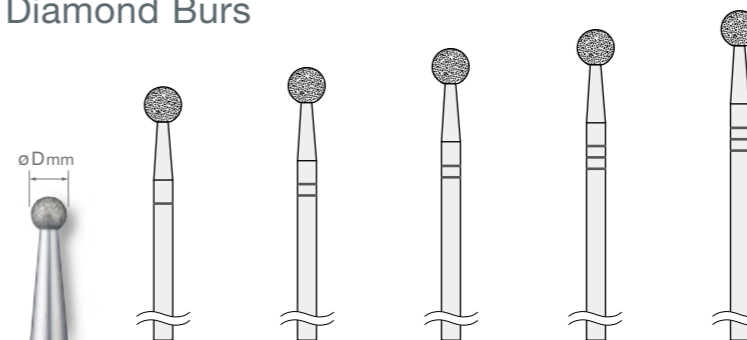

D Head Diameter	Short	Medium	Medium [Extended]	Long	Long [Extended]
	for P200-3GAS	for P200-3GAM	for P200-3GAM	for P200-3GAL	for P200-3GAL
1.0	PDS-3DS-10	PDS-3DM-10	—	—	—
2.0	PDS-3DS-20	PDS-3DM-20	PDS-3DM-20E	PDS-3DL-20	PDS-3DL-20E
3.0	PDS-3DS-30	PDS-3DM-30	—	PDS-3DL-30	—
4.0	PDS-3DS-40	PDS-3DM-40	—	PDS-3DL-40	—
5.0	PDS-3DS-50	PDS-3DM-50	—	PDS-3DL-50	—
6.0	PDS-3DS-60	PDS-3DM-60	—	PDS-3DL-60	—
7.0	PDS-3DS-70	PDS-3DM-70	—	PDS-3DL-70	—

Extended bur: Burs extend 10mm beyond Long type

P200-3GAS S

P200-3GAM M

P200-3GAL L



# ROTARY INSTRUMENTS $\varnothing 3.17\text{mm}$

## Coarse Diamond Burs

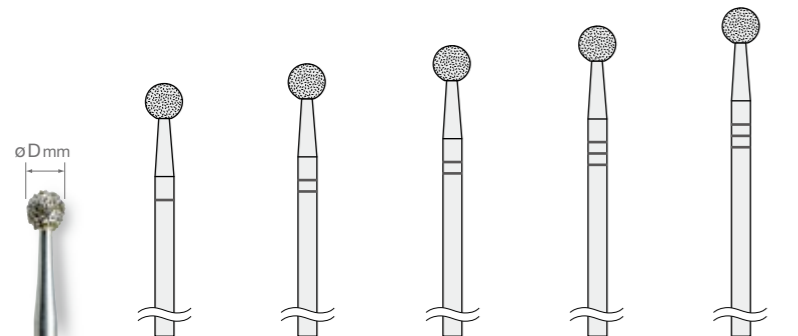

D Head Diameter	Short for P200-3GAS	Medium for P200-3GAM	Medium [Extended] for P200-3GAM	Long for P200-3GAL	Long [Extended] for P200-3GAL
2.0	PDS-3CDS-20	PDS-3CDM-20	—	PDS-3CDL-20	—
3.0	PDS-3CDS-30	PDS-3CDM-30	PDS-3CDM-30E	PDS-3CDL-30	PDS-3CDL-30E
4.0	PDS-3CDS-40	PDS-3CDM-40	PDS-3CDM-40E	PDS-3CDL-40	PDS-3CDL-40E
5.0	PDS-3CDS-50	PDS-3CDM-50	PDS-3CDM-50E	PDS-3CDL-50	PDS-3CDL-50E
6.0	PDS-3CDS-60	PDS-3CDM-60	—	PDS-3CDL-60	—
7.0	PDS-3CDS-70	PDS-3CDM-70	—	PDS-3CDL-70	—

Extended bur: Burs extend 10mm beyond Long type

## Acorn Burs

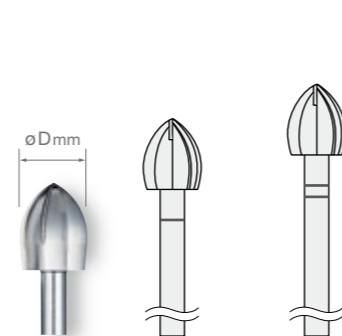

D Head Diameter	Short for P200-3GAS	Medium for P200-3GAM
7.5	PDS-3AS-75	PDS-3AM-75
9.0	PDS-3AS-90	PDS-3AM-90

# ROTARY INSTRUMENTS $\varnothing 3.17\text{mm}$

## Metal Cutter



D Head Diameter	for P200-3MC
1.6	PDS-3MCS-CB16
3.0	PDS-3MCS-CB30
25.4	PDS-3MCS-DD254

## Neuro Burs

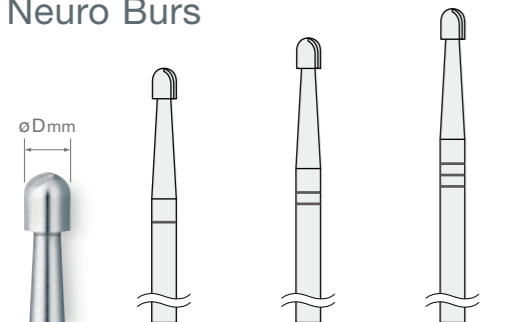

D Head Diameter	Short for P200-3GAS	Medium for P200-3GAM	Long for P200-3GAL
1.8	PDS-3NS-18	PDS-3NM-18	PDS-3NL-18
3.0	PDS-3NS-30	PDS-3NM-30	PDS-3NL-30

## Cylinder Burs

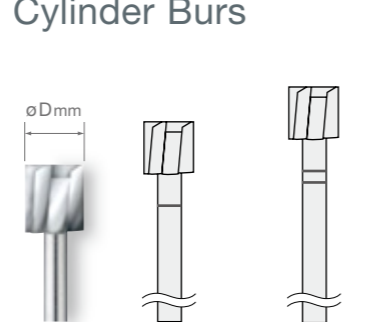

D Head Diameter	Short for P200-3GAS	Medium for P200-3GAM
6.0	PDS-3BS-60	PDS-3BM-60
9.1	PDS-3BS-91	PDS-3BM-91



# SAW BLADES

## Sagittal and Oscillating Saw Blades

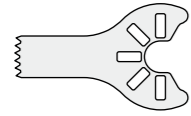

order code **PDS-SO-411**

- Depth : 11.5 mm
- Width : 5.5 mm
- Thickness : 0.4 mm

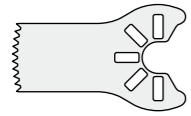

order code **PDS-SO-412**

- Depth : 11.5 mm
- Width : 9.0 mm
- Thickness : 0.4 mm

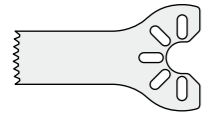

order code **PDS-SO-422**

- Depth : 15.0 mm
- Width : 7.0 mm
- Thickness : 0.4 mm

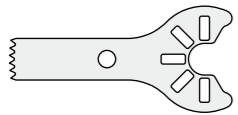

order code **PDS-SO-431**

- Depth : 18.0 mm
- Width : 5.5 mm
- Thickness : 0.4 mm

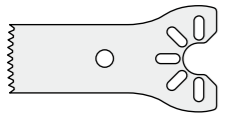

order code **PDS-SO-432**

- Depth : 18.0 mm
- Width : 9.0 mm
- Thickness : 0.4 mm

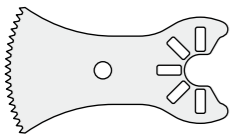

order code **PDS-SO-433**

- Depth : 18.5 mm
- Width : 16.5 mm
- Thickness : 0.4 mm

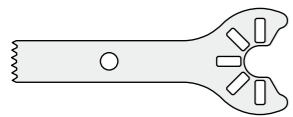

order code **PDS-SO-441**

- Depth : 25.0 mm
- Width : 5.5 mm
- Thickness : 0.4 mm

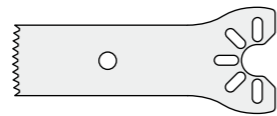

order code **PDS-SO-442**

- Depth : 25.0 mm
- Width : 9.3 mm
- Thickness : 0.4 mm

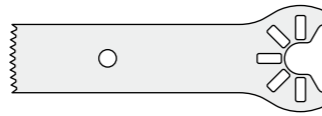

order code **PDS-SO-452**

- Depth : 31.0 mm
- Width : 9.0 mm
- Thickness : 0.4 mm

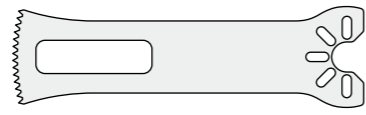

order code **PDS-SO-453**

- Depth : 39.0 mm
- Width : 13.2 mm
- Thickness : 0.4 mm

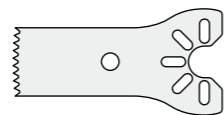

order code **PDS-SO-632**

- Depth : 18.0 mm
- Width : 9.0 mm
- Thickness : 0.6 mm

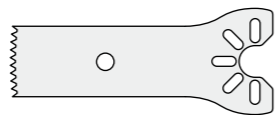

order code **PDS-SO-642**

- Depth : 25.0 mm
- Width : 9.3 mm
- Thickness : 0.6 mm

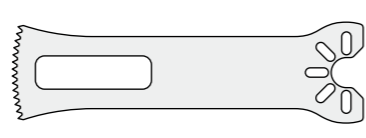

order code **PDS-SO-653**

- Depth : 39.0 mm
- Width : 13.2 mm
- Thickness : 0.6 mm

P200-SAG-S  
P200-SAG-S-HS



P200-OSC-S  
P200-OSC-S-HS



PD-SA-S



P200-OSC-S  
P200-OSC-S-HS



PD-OSC-A

# INTRA ORAL BLADES

## Oscillating Saw Blades (for Intra Oral)

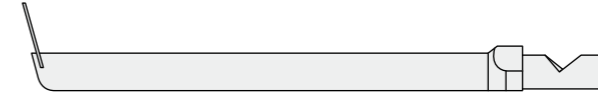

order code **PDS-OSC-422**

- Depth : 7.0 mm
- Width : 11.5 mm
- Thickness : 0.4 mm

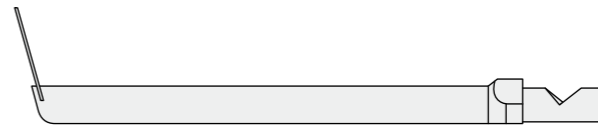

order code **PDS-OSC-432**

- Depth : 12.0 mm
- Width : 11.5 mm
- Thickness : 0.4 mm



Adaptor

order code **PD-OSC-A**

- For Oscillating Intra Oral Blades
- Bundled Item: Corresponding wrench (1), and screws (2)

# SAW BLADES

## Reciprocating Saw Blades

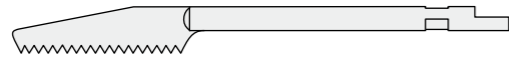

order code **PDS-RE-4023**

- Blade Length : 23.4 mm
- Thickness : 0.38 mm

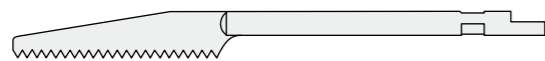

order code **PDS-RE-4028**

- Blade Length : 28.0 mm
- Thickness : 0.38 mm



order code **PDS-RE-4114**

- Blade Length : 14.5 mm
- Thickness : 0.4 mm

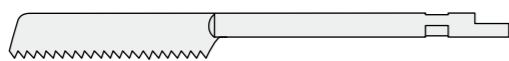

order code **PDS-RE-4127**

- Blade Length : 27.0 mm
- Thickness : 0.4 mm

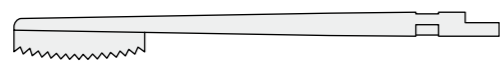

order code **PDS-RE-4217**

- Blade Length : 17.5 mm
- Thickness : 0.4 mm



order code **PDS-RE-4223**

- Blade Length : 23.0 mm
- Thickness : 0.4 mm

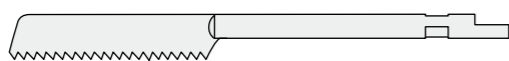

order code **PDS-RE-6127**

- Blade Length : 27.0 mm
- Thickness : 0.6 mm



P200-REC-S  
P200-REC-S-HS

PD-SA-R

# RASPS

## Reciprocating Rasps

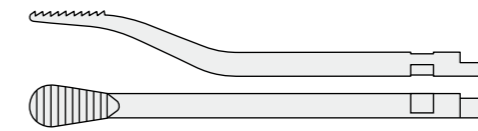

order code **PDS-RE-R011**

- Blade Length : 11.0 mm
- Thickness : 5.5 mm

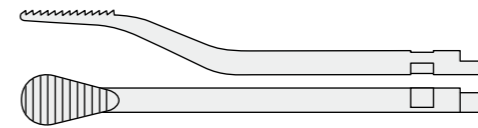

order code **PDS-RE-R012**

- Blade Length : 13.0 mm
- Thickness : 7.0 mm

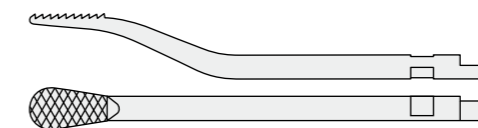

order code **PDS-RE-R111**

- Blade Length : 11.0 mm
- Thickness : 5.3 mm

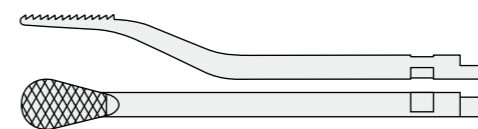

order code **PDS-RE-R112**

- Blade Length : 13.0 mm
- Thickness : 7.0 mm



P200-REC-S  
P200-REC-S-HS

PD-SA-R